

MULTICAL® 402

User Guide



Kamstrup

www.kamstrup.com

MULTICAL® 402

Energy Measurement

MULTICAL® 402 functions in the following way:

The flow meter registers the amount of district heating water in m³ (cubic metres) circulating through the heating system.

The temperature sensors placed in forward and return pipes register the cooling, i.e. the difference between input and output temperatures.

MULTICAL® 402 calculates consumed energy based on volume of district heating water and cooling.

Readings

When the top front key  is activated, a new reading appears.

The lower front key  displays historical readings and average values.

Four min. after the latest activation of the front key the meter automatically switches to consumed energy.



Kamstrup

MULTICAL® 402

English



USERS GUIDE



Kamstrup

Kamstrup A/S
Industrivej 28, Stilling, DK-8660 Skanderborg
Tel: +45 89 93 10 00 · Fax: +45 89 93 10 01
info@kamstrup.com · www.kamstrup.com

MID designations

Permissible operating conditions / measuring ranges

Calculator	θ : 2°C...160°C	$\Delta\theta$: 3K...150K
Temperature sensor set	θ : 10°C...150°C	$\Delta\theta$: 3K...140K
Flow sensor (heat meter)	θ : 15°C...130°C	

Also available as cooling meter with temperature range 2...50°C or as combined heat/cooling meter with temperature range 2...130°C, without MID approval however.

Mechanical environment

M1 (fixed installation with minimum vibration).

Electromagnetic environment

E1 (housing/light industry). The meter's control cables must be drawn at min. 25 cm distance to other installations.

Climatic environment

Must be installed in environments with non-condensing humidity as well as in closed locations (indoors). The ambient temperature must be within 5...55°C.

Maintenance and repair

The district heating supplier can replace communication module, battery and temperature sensor set. The flow sensor must not be separated from the calculator

Other repairs require subsequent reverification in an accredited laboratory.

MULTICAL® 402, type 402-W and 402-T must be connected to a temperature sensor set type Pt500.

MULTICAL® 402, type 402-V must be connected to a temperature sensor set type Pt100.

Battery for replacement

Kamstrup type 402-000-2000-000 (D-cell) or 402-000-1000-000 (2 x AA-cells).

Contents

1	General information	4
2	Mounting of temperature sensors	4
2.1	<i>Pocket sensor set</i>	5
2.2	<i>Short direct sensor set</i>	6
3	Information codes "INFO"	6
4	Mounting of flow sensor	7
4.1	<i>Mounting of glands and short direct sensor mounted in MULTICAL® 402 flow part</i>	7
4.2	<i>Mounting of MULTICAL® 402</i>	10
4.3	<i>Installation examples</i>	11
5	Mounting the calculator	12
5.1	<i>Compact mounting</i>	12
5.2	<i>Wall mounting</i>	12
6	Power supply	13
6.1	<i>Battery supply</i>	13
6.2	<i>Mains modules</i>	13
7	Testing the function	14
8	Electrical connection	14
9	Plug-in modules	15
9.1	<i>Pulse inputs</i>	15
9.2	<i>Pulse outputs</i>	15
9.3	<i>Data + pulse inputs, type 402-0-10</i>	16
9.4	<i>Data + pulse outputs, type 402-0-11</i>	16
9.5	<i>M-Bus + pulse inputs, type 402-0-20</i>	17
9.6	<i>M-Bus + pulse outputs, type 402-0-21</i>	17
9.7	<i>M-Bus module with MULTICAL® III data package + pulse inputs, type 402-0-29</i>	17
9.8	<i>Wireless M-Bus, type 402-0-30 and 402-0-35</i>	18
9.9	<i>Radio, type 402-0-40 and 402-0-41</i>	18
9.10	<i>Radio+ pulse inputs, type 402-0-42 and 402-0-44</i>	18
9.11	<i>Radio+ pulse outputs, type 402-0-43 and 402-0-45</i>	19
9.12	<i>Module overview</i>	20
10	Setup via front keys	21

1. General information

 Read this guide before installing the meter.

In case of incorrect mounting Kamstrup's guarantee obligations no longer apply.

Please note that the following installation conditions must be obeyed:

- Pressure stage PN16/PN25, see marking. The flow sensor marking does not apply to enclosed accessories
- Pressure stage, Kamstrup sensor set type DS: PN16
- Pressure stage, Kamstrup stainless steel pockets: PN25

At medium temperatures above 90°C in flow sensor, use of flange meters is recommended, and the calculator should be wall-mounted.

2. Mounting of temperature sensors

The temperature sensors used to measure flow and return temperatures are a matched sensor set that must never be separated.

MULTICAL® 402 is by default supplied with mounted temperature sensors. According to EN 1434 the cable length must not be changed. If necessary, sensors must always be replaced in pairs.

One sensor is marked with a red sign and must be installed in the flow pipe. The other sensor is marked with a blue sign and must be installed in the return pipe (see paragraph 8, page 14).

2.1 Pocket sensor set

Preferably, sensor pockets must be mounted in tee-pieces or in 45° lateral Y-pieces. The tip of the sensor pocket must point against the flow direction and be placed in the middle of the water flow.

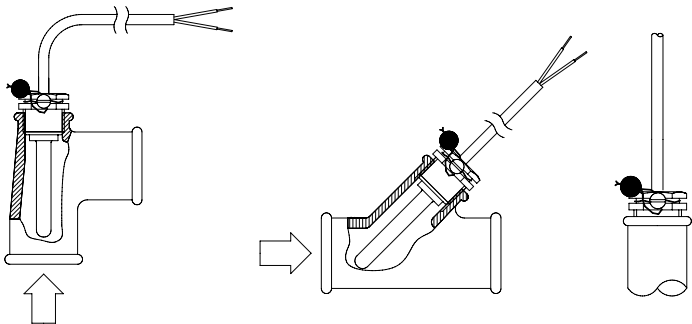

Temperature sensors should be inserted to the bottom of the pockets. If a short response time is required, “non-hardening” heat conducting paste can be used.

Push the plastic sleeve on the sensor cable into the sensor pocket and secure the cable with the enclosed M4 sealing screw. Fasten the screw with your fingers only. Seal the pockets using seal and locking wire.

2.2 Short direct sensor set

Short direct sensors can be mounted in special ball valves or in special tee-pipes, both with threads up to R1 and built-in M10 union for the short direct sensor.

For mounting in existing heating installations with standard angle tees Kamstrup A/S can supply R $\frac{1}{2}$ and R $\frac{3}{4}$ brass nipples fitting the short direct sensors.

Short direct sensors can also be fitted directly into all Kamstrup's ULTRAFLOW® variants with G $\frac{3}{4}$ and G1 threads on the meter case. Fasten the brass unions of the sensors lightly (approx. 4 Nm) using a 12 mm face wrench and seal the sensors with seal and locking wire.

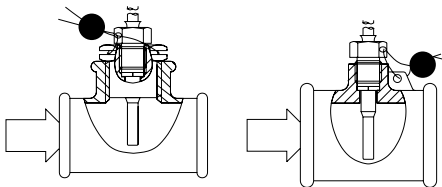

3. Information codes "INFO"

MULTICAL® 402 constantly monitors a number of important functions. If there is a serious error in the measuring system or installation, a flashing "INFO" is displayed, and an info code can be read by activating the top front key until the measuring unit displays "INFO". The info code is visible as long as the error exists, unless the meter has been specially configured for "manual reset of info codes". When an info code has existed for an hour, it is saved in the info log.

Info Code	Description	Response time
0	No irregularities	-
1	Supply voltage has been interrupted	-
8	Temperature sensor T1 outside measuring range	< 30 sec.
4	Temperature sensor T2 outside measuring range	< 30 sec.
4096	Flow sensor V1, signal too weak (air)	< 30 sec.
16384	Flow sensor with wrong flow direction	< 30 sec.

If several info codes appear at a time, the sum of the info codes is displayed. If e.g. both temperature sensors are outside measuring range, info code 12 is displayed.

4. Mounting of flow sensor

Prior to installation of the flow sensor, the system should be flushed and protection plugs/plastic diaphragms removed from the flow sensor. Correct flow sensor position (forward or return pipe) appears from the front label of the MULTICAL® 402. The flow direction is indicated by an arrow on the side of the flow sensor.

4.1 Mounting of glands and short direct sensor mounted in MULTICAL® 402 flow part

The short direct sensor from Kamstrup can only be mounted in PN16 installations. The blind plug mounted in the MULTICAL® 402 flow part can be used in connection with both PN16 and PN25.

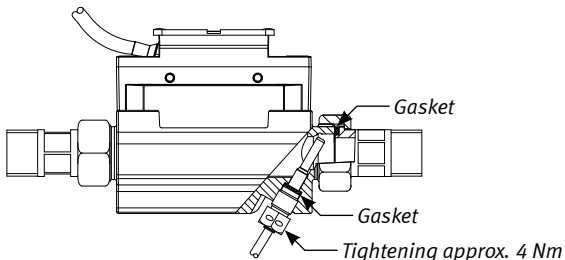

The flow meter can be used in both PN16 and PN25 and can be supplied marked either PN16 or PN25 as desired.

Possibly supplied glands can only be used for PN16. For PN25 installations shall be used suitable PN25 glands.

In connection with G³/₄x110 mm and G1x110 mm it shall be checked that 10 mm thread run-out is sufficient. See the figure below.

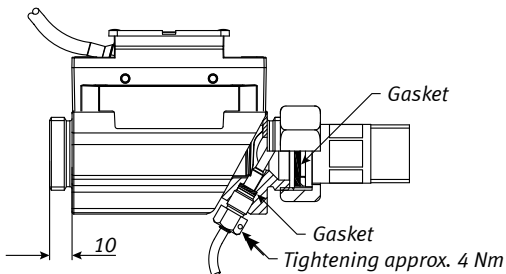

Straight inlet: MULTICAL® 402 requires neither straight inlet nor straight outlet to meet the Measuring Instruments Directive (MID) 2004/22/EC and EN 1434:2007. A straight inlet section will only be necessary in case of heavy flow disturbances before the meter. We recommend to follow the guidelines of CEN CR 13582.

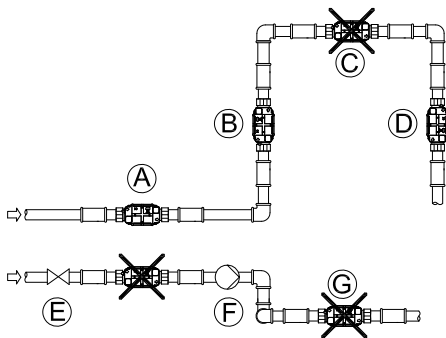

- A** Recommended flow sensor position
- B** Recommended flow sensor position
- C** Unacceptable position due to risk of air build-up
- D** Acceptable in closed systems. Unacceptable position in open systems due to risk of air build-up in the system
- E** A flow meter ought not to be placed immediately after a valve, with the exception of block valves (ball valve type) which must be fully open when not used for blocking
- F** A flow meter must never be placed on the inlet side of a pump
- G** A flow meter ought not to be placed after a double bend in two levels.

In order to prevent cavitation the operating pressure at MULTICAL® 402 must be min. 1.5 bar at q_p and min. 2.5 bar at q_s . This applies to temperatures up to approx. 80°C.

MULTICAL® 402 must not be exposed to pressure lower than the ambient pressure (vacuum).

4.2 Mounting of MULTICAL® 402

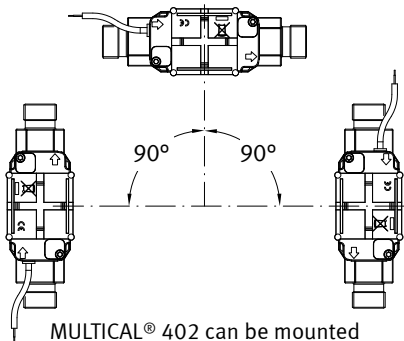

MULTICAL® 402 can be mounted vertically, horizontally or at an angle

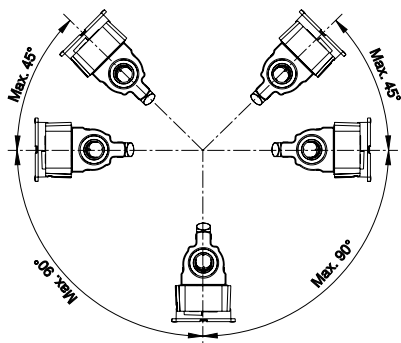

MULTICAL® 402 may be turned up to max. 45° and downwards for max. 90° in relation to the pipe axis.

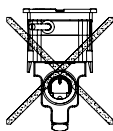

MULTICAL® 402 must not be mounted with the plastic box pointing upwards

4.3 Installation examples

Threaded meter:

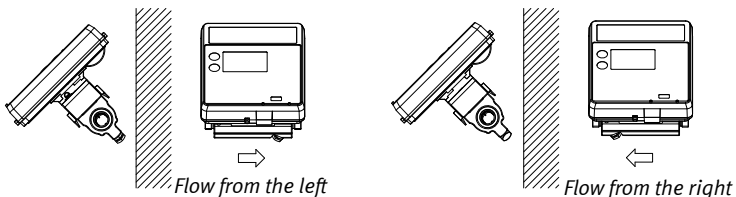

Flange meter:

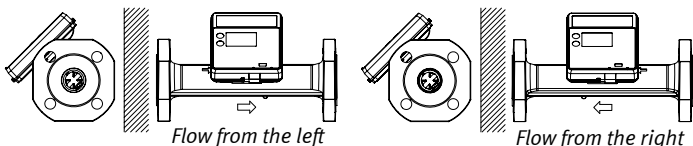

4.3.1 Humidity and condensation

If MULTICAL® 402 is installed in moist environments, it must be turned 45° relative to the pipe axis as shown in the drawing below.

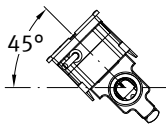

If there is risk of condensation, e.g. in cooling systems, a condensation protected MULTICAL® 402 must be used.

5. Mounting the calculator

The MULTICAL® 402 calculator can be mounted in two different ways:

5.1 Compact mounting

The calculator is mounted direct on the flow sensor. After mounting the calculator is sealed with seal and locking wire. In case of strong condensation (e.g. cooling applications) we recommend wall mounting of the calculator. Furthermore, MULTICAL® 402 must be the condensation protected version.

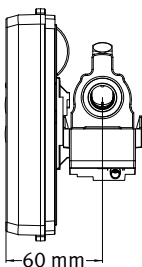

If minimum installation depth (G $\frac{3}{4}$ and G1) is required, the flow sensor is mounted with the plastic case pointing downwards and the calculator on the side

5.2 Wall mounting

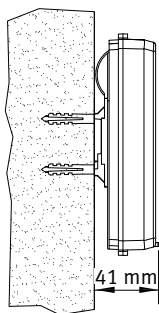

The wall fitting makes it possible to mount MULTICAL® 402 direct on an even wall. Use the fitting as a template for marking and drilling two 6 mm holes in the wall

6. Power supply

MULTICAL® 402 can be powered by a built-in lithium battery or by an integral 24 VAC or 230 VAC mains module.

The two wires from battery or mains module are mounted in the calculator via a two-contacts connector.

6.1 Battery supply

MULTICAL® 402 is connected to a lithium battery, D-cell or 2 x AA-cells.

Optimal battery lifetime is obtained by keeping the battery temperature below 30°C, e.g. by wall mounting.

The voltage of a lithium battery is almost constant throughout the lifetime of the battery (approx. 3.65 V). Therefore, it is not possible to determine the remaining capacity of the battery by measuring the voltage.

The battery cannot and must not be charged and must not be short-circuited. Used batteries must be handed in for approved de-struction, f.inst. at Kamstrup A/S.

6.2 Mains modules

The modules are protection class II and are connected via a two-wire cable (without earth) through the cable bush of the calculator placed in the right side of the connecting base. Use connecting cable with an outer diameter of 5-10 mm and ensure correct dismantling as well as correct mounting of cable relief.

Max. permitted fuse: 6 A

National installation regulations must be obeyed.

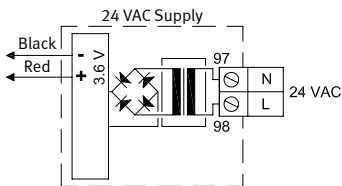

24 VAC

F.inst. transformer 230/24 V, type 66-99-403, can be used.

Note! MULTICAL® 402 cannot be supplied by 24 VDC.

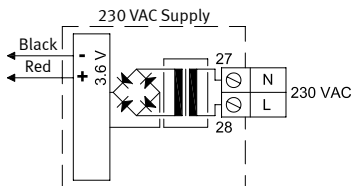

230 VAC

This module is used for direct mains connection.

Note! External supply must be connected to the supply module

7. Testing the function

Carry out an operational check when the energy meter has been fully mounted. Open thermoregulators and cocks to establish water flow through the heating system. Activate the top key on MULTICAL® 402 and check that the displayed values for temperatures and water flow are credible values.

8. Electrical connection

The two paired 2-wire sensors must be mounted in terminals 5 and 6 (T1), and 7 and 8 (T2). The polarity of temperature sensors T1 and T2 is unimportant.

See the position of the terminals below:

	Terminal no.	Standard heat and cooling measurement
T1	5–6	Sensor in forward pipe (red)
T2	7–8	Sensor in return pipe (blue)

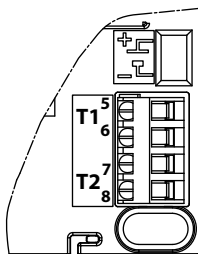

9. Plug-in modules

A number of extra functions can be added to MULTICAL® 402 by means of plug-in modules. The individual modules are briefly described below.

9.1 Pulse inputs

Pulse inputs (VA) and (VB) are used for the connection of extra water meters with either Reed switch output or passive electronic pulse output. Min. pulse duration is 30 msec. and max. pulse frequency is 0.5 Hz.

If a module with pulse inputs is mounted in MULTICAL® 402, the meter is automatically configured for pulse inputs.

Please note that the pulse figure (litres/pulse) must match between the extra water meters and the configuration of VA and VB. After delivery the configuration of VA and VB (config FF and GG) can be changed by means of the PC program METERTOOL.

65	+	(VA) Pulse input
66	-	

67	+	(VB) Pulse input
68	-	

9.2 Pulse outputs

Pulse outputs for energy (CE) and volume (CV) are designed with darlington optocouplers and are available with many of the plug-in modules. Max. voltage and current is 30 VDC and 10 mA.

If a module with pulse outputs is mounted in MULTICAL® 402, the meter is automatically configured for pulse outputs. The pulse duration is ordered at 32 msec. or 0.1 sec. After delivery the pulse duration can be changed by means of the PC program METERTOOL.

The resolutions of the pulse outputs always follow the least significant digits of energy and volume respectively in the display.

16	+	(CE) Pulse output for energy
17	-	

18	+	(CV) Pulse output for volume
19	-	

9.3 Data + pulse inputs, type 402-0-10

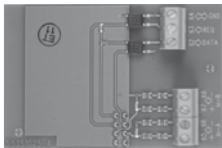

The data terminals are used for connection of e.g. a PC. The signal is passive and galvanically separated by means of optocouplers. Conversion into RS232 level requires connection of data cable 66-99-106 (D-Sub 9F) or 66-99-098 (USB) with the following connections:

62	Brown	(DAT)
63	White	(REQ)
64	Green	(GND)

9.4 Data + pulse outputs, type 402-0-11

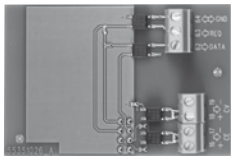

The data terminals are used for connection of e.g. a PC. The signal is passive and galvanically separated by means of optocouplers. Conversion into RS232 level requires connection of data cable 66-99-106 (D-Sub 9F) or 66-99-098 (USB) as follows:

62	Brown	(DAT)
63	White	(REQ)
64	Green	(GND)

 Mounting an external antenna it must be secured that the antenna cable does not become caught between the PCB and the stay of the cover.

Replacing or mounting modules the meter must be without current. The same applies when mounting an external antenna.

9.5 M-Bus + pulse inputs, type 402-0-20

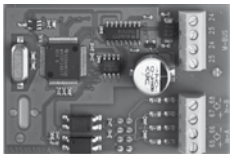

M-Bus module with primary, secondary and enhanced secondary addressing.

The module is connected to an M-Bus master via terminals 24 and 25 using a twisted pair.

The polarity is unimportant.

The module is powered by the connected master.

9.6 M-Bus + pulse outputs, type 402-0-21

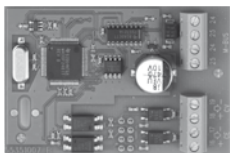

M-Bus module with primary, secondary and enhanced secondary addressing.

The module is connected to an M-Bus master via terminals 24 and 25 using a twisted pair.

The polarity is unimportant.

The module is powered by the connected master.

9.7 M-Bus module with MULTICAL® III data package + pulse inputs, type 402-0-29

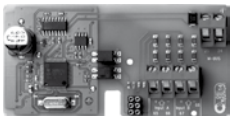

The M-Bus module 402029 comprises the same data packet as M-Bus module 6604 for MULTICAL® III/66-C and module 660S for MULTICAL® Compact/MULTICAL® 401.

The module can e.g. be used together with the old M-Bus master with display, old regulators and old reading systems not supporting the newer M-Bus modules.



Mounting an external antenna it must be secured that the antenna cable does not become caught between the PCB and the stay of the cover.

Replacing or mounting modules the meter must be without current. The same applies when mounting an external antenna.

9.8 Wireless M-Bus, type 402-0-30 and 402-0-35

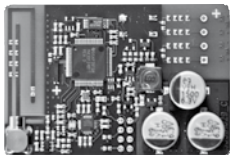

The radio module has been designed to form part of Kamstrup's hand-held Wireless M-Bus Reader system, which operates in the licence-free frequency band in the 868 MHz area.

The radio module comes fitted with internal antenna as well as connection for external antenna.

9.9 Radio, type 402-0-40 and 402-0-41

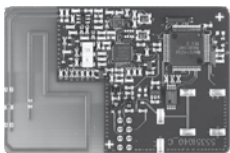

These radio modules are your first choice for reading via Kamstrup's hand-held reading systems, e.g. USB Meter Reader and hand-held terminal MT Pro, which operate in the licence-free frequency band in the 434 MHz area.

The radio module comes fitted with internal antenna.

9.10 Radio+ pulse inputs, type 402-0-42 and 402-0-44

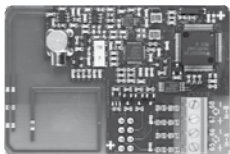

The radio modules have been optimized to form part of a Kamstrup radio network system, which operates in the licence-free frequency band in the 434 MHz area, but can also be used for the hand-held reading systems in the same frequency area.

The radio module comes fitted with internal antenna as well as connection for external antenna and two pulse inputs.

 Mounting an external antenna it must be secured that the antenna cable does not become caught between the PCB and the stay of the cover.

Replacing or mounting modules the meter must be without current. The same applies when mounting an external antenna.

9.11 Radio+ pulse outputs, type 402-0-43 and 402-0-45

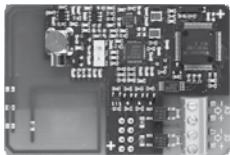

The radio modules have been optimized to form part of a Kamstrup radio network system, which operates in the licence-free frequency band in the 434 MHz area, but can also be used for the hand-held reading systems in the same frequency area.

The radio module comes fitted with internal antenna as well as connection for external antenna and two pulse outputs.



Mounting an external antenna it must be secured that the antenna cable does not become caught between the PCB and the stay of the cover.

Replacing or mounting modules the meter must be without current. The same applies when mounting an external antenna.

9.12 Module overview

MULTICAL® 402 Communication modules

Type No.	Description	Module No.
402-0-10	Data + 2 pulse inputs (VA, VB)	5550-1025
402-0-11	Data + 2 pulse outputs (CE, CV)	5550-1026
402-0-20	M-Bus + 2 pulse inputs (VA, VB)	5550-1030
402-0-21	M-Bus + 2 pulse outputs (CE, CV)	5505-1007
402-0-29	M-Bus + 2 pulse inputs - MULTICAL® III compatible data	5505-1140
402-0-30	Wireless M-Bus, C1, encrypted, 868 MHz, internal and external antenna	5550-1029
402-0-35	Wireless M-Bus, C1, alternative registers, encrypted, 868 MHz, internal and external antenna, pulse inputs	5550-1203
402-0-40	Radio, EU, 434 MHz, int. ant., NET0	5550-1040
402-0-41	Radio, EU, 434 MHz, int. ant., NET1	5505-1040
402-0-42	Radio, EU, 434 MHz, int. + ext. ant., NET0 + 2 pulse inputs (VA, VB)	5550-1072
402-0-43	Radio, EU, 434 MHz, int. + ext. ant., NET0 + 2 pulse outputs (CE, CV)	5550-1072
402-0-44	Radio, EU, 434 MHz, int. + ext. ant., NET1 + 2 pulse inputs (VA, VB)	5550-1072
402-0-45	Radio, EU, 434 MHz, int. + ext. ant., NET1 + 2 pulse outputs (CE, CV)	5550-1074

10. Setup via front keys

Date, time and primary M-Bus address can be adjusted by means of the keys on the calculator's front.

- 1 In the display you select the reading you want to change
- 2 Disconnect the supply plug from the meter
- 3 Wait until the meter has switched off (up to 2.5 minutes).
Do not press any keys
- 4 Keep pressing the main key  while the supply is connected to the meter (connecting the supply plug to the meter) until no lines are shown in the display
- 5 The setup menu is now active

Having activated the setup menu the reading you want to change is displayed and at the same time the digit at the far right of the display flashes:



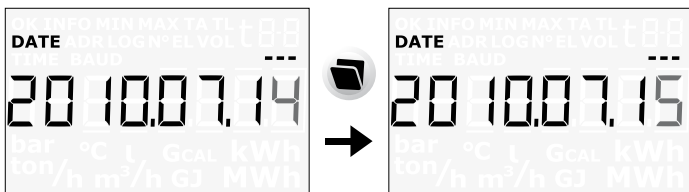

The value of the flashing digit can be changed by pressing the subkey . The digit is increased by one each time you press the key, and at 9 it reverts to 0:

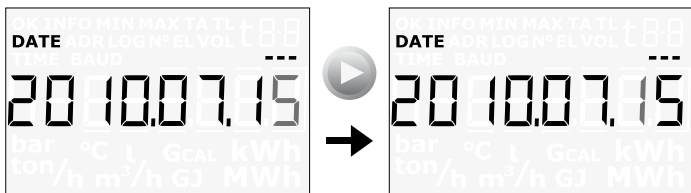

Pressing the main key  you go to the next digit from right to left:



The active digit flashes and this digit can now be changed by pressing the subkey . You go to the first digit on the right by means of the main key .

When the value of the reading has been changed you quit by pressing the main key  continuously for 5-6 seconds.

Now check whether the value is valid for the reading in question. If so, the value is saved and the new value is displayed with the “OK” symbol on. If not, the old value is displayed without the “OK” symbol.



Consumed energy in kWh,
MWh or GJ

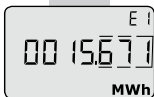

Latest target date



Energy count on latest target
date followed by energy
count on last year's target
date
Followed by monthly counts

Consumed district heating
water



Latest target date



Volume count on latest
target date followed by
volume count on last year's
target date
Followed by monthly counts

Number of operating hours



Current forward
temperature

(*) Press to view yearly and
monthly average values



Current return temperature

(*) Press to view yearly and
monthly average values



Current differential
temperature (cooling)



Current water flow

(*) Press to see this year's
max. value as well as
yearly and monthly logging
values



Current heat-flow rate

(*) Press to see this year's
max. value as well as
yearly and monthly logging
values.
*Followed by totalized water
consumption on input A
and B.*

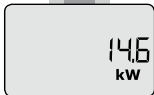



Current information code
(Contact your district heating
company if the value differs
from "0")

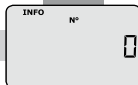
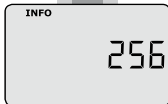

Reading of number of INFO
code events



Data logger shows the
date ...



... and then the INFO codes
of the latest 36 events

The eight most significant
digits of the customer
number



The eight least significant
digits of the customer
number. In this example
the customer number is
12345678912

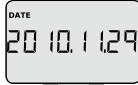

Current date



Current time



Target date displayed as
month and day. In this
example 1 June



The calculator's serial
number



The calculator's program
number.
In this example: Flow meter
in return pipe, MWh and 100
imp/l.



Followed by the calculator's
configuration number and
software edition.

Display test

DDD = 213
(* DDD = 212

Also see interactive user guides at
www.kamstrup.com